



# SCT2A00

---

## REVISION HISTORY

## RECOMMENDED OPERATING CONDITIONS

Over operating free-air temperature range unless otherwise noted

PARAMETER	DEFINITION	MIN	MAX	UNIT
V <sub>IN</sub>	Input voltage range	5.5	100	V
V <sub>OUT</sub>	Output voltage range	1.2	30	V
T <sub>J</sub>	Operating junction temperature	-40	150	°C

## ESD RATINGS

PARAMETER	DEFINITION	MIN	MAX	UNIT
V <sub>ESD</sub>	Human Body Model(HBM), per ANSI-JEDEC-JS-001-2014 specification, all pins <sup>(1)</sup>	-2	+2	kV
	Charged Device Model(CDM), per ANSI-JEDEC-JS-002-2014 specification, all pins <sup>(2)</sup>	-1	+1	kV

(1) JEDEC document JEP155 states that 500V HBM allows safe manufacturing with a standard ESD control process.

(2) JEDEC document JEP157 states that 250V CDM allows safe manufacturing with a standard ESD control process.

## THERMAL INFORMATION

PARAMETER	THERMAL METRIC	SOT23-6L	UNIT
R <sub>JA</sub>	Junction to ambient thermal resistance <sup>(1)</sup>	136.53	°C/W
J <sub>T</sub>	Junction-to-top characterization parameter	22.56	
J <sub>B</sub>	Junction-to-board characterization parameter <sup>(1)</sup>	31.01	
R <sub>JCtop</sub>	Junction to case thermal resistance <sup>(1)</sup>	153.16	
R <sub>JB</sub>	Junction-to-board thermal resistance <sup>(1)</sup>	31.89	

(1) SCT provides R<sub>JA</sub> and R<sub>JC</sub> numbers only as reference to estimate junction temperatures of the devices. R<sub>JA</sub> and R<sub>JC</sub> are not a characteristic of package itself, but of many other system level characteristics such as the design and layout of the printed circuit board (PCB) on which the SCT2A00 is mounted, thermal pad size, and external environmental factors. The PCB board is a heat sink that is soldered to the leads and thermal pad of the SCT2A00. Changing the desi

# SCT2A00

---

## ELECTRICAL CHARACTERISTICS

$V_{IN}=48V$ ,  $T_J=-40^{\circ}C\sim 125^{\circ}C$ , typical value is tested under  $25^{\circ}C$ .

---

SYMBOL	PARAMETER	TEST CONDITION	MIN	TYP	MAX	UNIT
--------	-----------	----------------	-----	-----	-----	------

TYPICAL CHARACTERISTICS

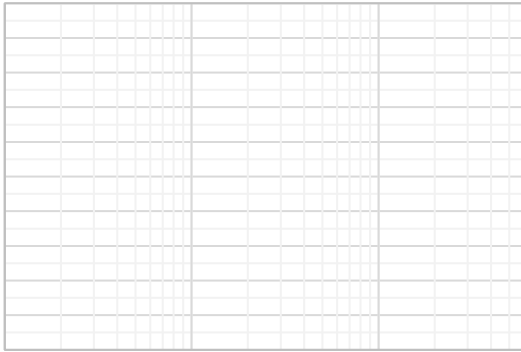

Figure 2. Efficiency vs Load Current, Vout=5V

Figure 3. Efficiency vs Load Current, Vout=12V

Figure 4. Load Regulation, Vin=24V, Vout=5V

Figure 5. Load Regulation, Vin=48V, Vout=12V

Figure 6. Line Regulation, Iout=0.6A

Figure 7. Switching Frequency vs Vin, Vout=12V

# SCT2A00

## FUNCTIONAL BLOCK DIAGRAM

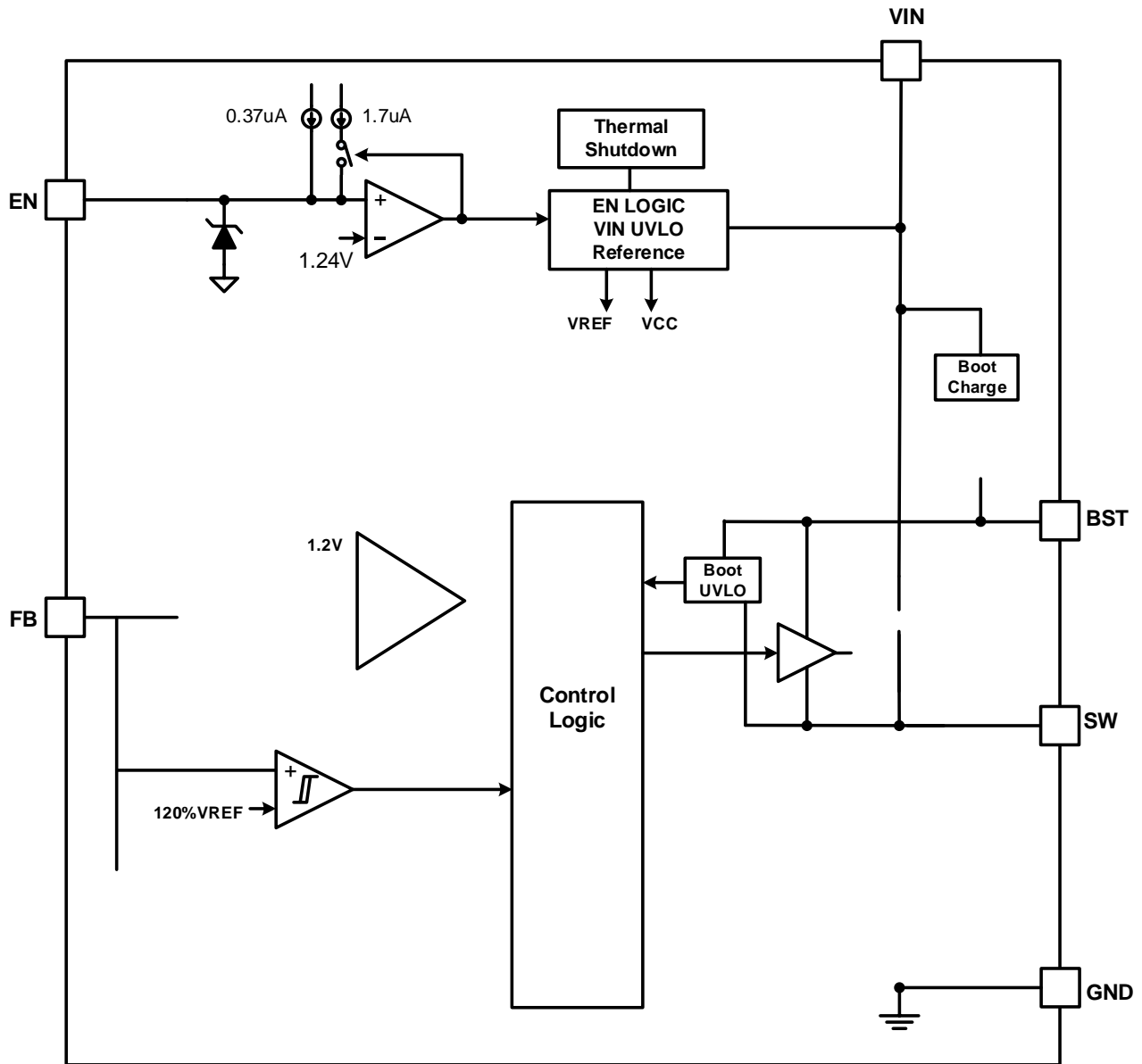

Figure 8. Functional Block Diagram

## OPERATION

### Overview

The SCT2A00 is a 5.5V-100V input, 1.3A peak current limit, Step-down DCDC converter with built-in 975mΩ high-side power MOSFET. It implements constant on time control to regulate output voltage, providing excellent line and load transient response, and internal error amplifier integrated improve the line and load regulation.

The SCT2A00 features an internal 3.5ms soft-start time to avoid large inrush current and output voltage overshoot during startup. The switching frequency is fixed at 270KHz. The device also supports monolithic startup with pre-biased output condition.

The SCT2A00 has a default input start-up voltage of 5V with 420mV hysteresis. The EN pin has a precision threshold that can be used to adjust the input voltage lockout thresholds with two external resistors to meet accurate higher UVLO system requirements. Floating EN pin enables the device with the internal pull-up current to the pin.

The SCT2A00 full protection features include the VIN input under-voltage lockout, the output over-voltage and under-voltage protection, over current protection with cycle-by-cycle current limit, output hard short protection and thermal shutdown protection.

### Constant On-Time Mode Control

The SCT2A00 employs constant on-time (COT) Mode control providing fast transient with pseudo fixed switching frequency. At the beginning of each switching cycle, since the feedback voltage (VFB) is lower than the internal reference voltage (VREF), the high-side MOSFET (Q1) is turned on during one on-time and the inductor current rises to charge up the output voltage. The on-time is determined by the input voltage and output voltage. After the on-time, the high-side MOSFET (Q1) turns off. The inductor current drops and the output capacitors are discharged. When the output voltage decreases and the VFB decreased below the VREF or SS, the Q1 turns on again after another dead time duration. This repeats on cycle-by-cycle.

The SCT2A00 works with an internal compensation, so customer could use the device easily. Feedforward cap C<sub>f</sub> is necessary to provide flexibility for optimizing the loop stability and transient response.

### Enable and Under Voltage Lockout Threshold

The SCT2A00 is enabled when the VIN pin voltage rises above 5V and the EN pin voltage exceeds the enable threshold of 1.24V. The device is disabled when the VIN pin voltage falls below 4.58V or when the EN pin voltage is below 1.23V. Internal pull up current source to EN pin allows the device enable when EN pin floats.

There is a Zener diode inside the EN pin. When the voltage of the EN pin is higher than 6.3V, the Zener diode conducts to clamp the voltage. To protect the Zener diode, the current flowing through it cannot exceed 200uA.

For a higher system UVLO threshold, connect an external resistor divider (R3 and R4) shown in Figure 9 from VIN to EN. The UVLO rising and falling threshold can be calculated by Equation 1 and Equation 2 respectively.

$$\begin{aligned}
 & \text{---} & (1) \\
 & & (2)
 \end{aligned}$$

Where

VIN<sub>rise</sub>: Vin rise threshold to enable the device

VIN<sub>hys</sub>: Vin hysteresis threshold

I<sub>2</sub>=1.7uA

V<sub>EN,H</sub>=1.24V

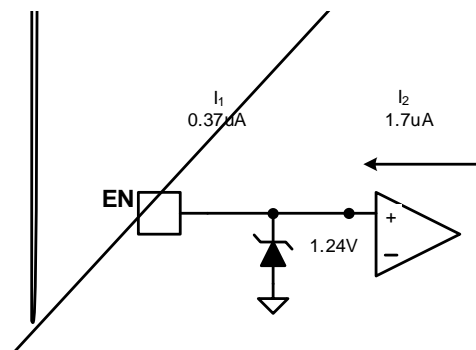

Figure 9. System UVLO by enable divide

# SCT2A00

---

## Output Voltage

The SCT2A00 regulates the internal reference voltage at 1.2V. The output voltage is set by a resistor divider from the output node to the FB pin. It is recommended to use 1% tolerance or better resistors. Use Equation 3 to calculate resistance of resistor dividers. To improve efficiency at light loads, larger value resistors are recommended. However, if the values are too high, the regulator will be more susceptible to noise affecting output voltage accuracy.

$$\text{---} \tag{3}$$

where

- $R_{FB\_TOP}$  is the resistor connecting the output to the FB pin.
- $R_{FB\_BOT}$  is the resistor connecting the FB pin to the ground.

## Internal Soft-Start

The SCT2A00 integrates an internal soft-start circuit that ramps the reference voltage from zero volts to 1.2V reference voltage in 3.5ms. If the EN pin is pulled below 1.23V, switching stops and the internal soft-start resets. The soft-start also resets during shutdown due to thermal overloading.

## Bootstrap Voltage Regulator

An external bootstrap capacitor between BOOT pin and SW pin powers the floating gate driver to high-side power MOSFET. The bootstrap capacitor voltage is charged from an integrated voltage regulator when high-side power MOSFET is off.

The UVLO of high-side MOSFET gate driver has rising threshold of 3.19V and hysteresis of 290mV. When the device operates with high duty cycle or extremely light load, bootstrap capacitor may be not recharged in considerable long time. The voltage at bootstrap capacitor is insufficient to drive high-side MOSFET fully on. When the voltage across bootstrap capacitor drops below 2.9V, BOOT UVLO occurs. The converter forces turning off high-side MOSFET to refresh the voltage of bootstrap capacitor to guarantee the converter's operation over a wide duty range.

To maintain bootstrap capacitor voltage, please output at least 10mA load current when  $V_{IN} - V_{OUT} < 2V$ , at least 30mA load current when  $V_{IN} - V_{OUT} < 1V$ .

## Over Current Limit, Hiccup Mode and Under Voltage Protection

The inductor current is monitored during high-side FET turn on. The SCT2A00 implements over current protection with cycle-by-cycle limiting high-side MOSFET peak current during unexpected overload or output hard short.

When overload or hard short happens, the converter cannot provide output current to satisfy loading requirement. The inductor current is clamped at over current limitation. Thus, the output voltage drops below regulated voltage with FB voltage less than internal reference voltage continuously ( $V_{UVP\_F}$ ), the converter stops switching. After remaining OFF for 7 SS cycles the device restarts from soft starting phase. If overload or hard short condition still exists during soft-start and make FB voltage lower than  $V_{UVP\_R}$ , the device enters into turning-off mode again. When overload or hard short condition is removed, the device automatically recovers to enters normal regulating operation.

SCT2A00 also provide a HS current limit off timer for making the IC safer when trigger over current condition. Once trigger HS over current, the present on-time period is immediately terminated to avoid the inductor current run away. The length of off time is controlled by FB voltage and VIN voltage and could be calculated by the following equation.

$$\text{---} \tag{4}$$

## Over Voltage Protection

The SCT2A00 implements the Over-voltage Protection OVP circuitry to minimize output voltage overshoot during load transient, recovering from output fault condition or light load transient. The overvoltage comparator in OVP

circuit compares the FB pin voltage to the internal reference voltage. When FB voltage exceeds 120% of internal 1.2V reference voltage, the high-side MOSFET turns off to avoid output voltage continue to increase. When the FB pin voltage falls below 115% of the 1.2V reference voltage, the high-side MOSFET can turn on again.

## **Thermal Shutdown**

The SCT2A00 protects the device from the damage during excessive heat and power dissipation conditions. Once the junction temperature exceeds 155°C, the internal thermal sensor stops power MOSFETs switching. When the junction temperature falls below 142°C, the device restarts with internal soft start phase.

# SCT2A00

---

## APPLICATION INFORMATION

### Typical Application

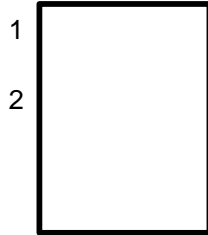

Figure 10. SCT2A00 Design Example, 12V Output with Programmable UVLO

#### Design Parameters

Design Parameters	Example Value
Input Voltage	48V Normal 15V to 100V
Output Voltage	12V
Maximum Output Current	0.6A
Switching Frequency	270 KHz
Output voltage ripple (peak to peak)	19mV
Transient Response 0.15A to 0.45A load step	Vout =68mV

## Output Voltage

The output voltage is set by an external resistor divider  $R_1$  and  $R_2$  in typical application schematic. Recommended  $R_2$  resistance is 30K . Use equation 5 to calculate  $R_1$ .

Table 1.  $R_1, R_2$  Value for Common Output Voltage (Room Temperature)

$V_{out}$	$R_1$	$R_2$
-----------	-------	-------

$$\text{---} \quad (5)$$

where:

- $V_{REF}$  is the feedback reference voltage, typical 1.2V

# SCT2A00

---

Where

- $I_{LPP}$  is the inductor peak-to-peak current
- $L$  is the

For the example design, the SS310B Schottky diode is selected for its lower forward voltage and good thermal characteristics compared to smaller devices. The typical forward voltage of the SS310B is 0.6V at 0.6A.

The diode must also be selected with an appropriate power rating. The diode conducts the output current during the off-time of the internal power switch. The off-time of the internal switch is a function of the maximum input

# SCT2A00

---

A 0.1 $\mu$ F ceramic capacitor must be connected between BOOT pin and SW pin for proper operation. A ceramic capacitor with X5R or better grade dielectric is recommended. The capacitor should have a 10V or higher voltage rating.

## Output Capacitor Selection

The selection of output capacitor will affect output voltage ripple in steady state and load transient performance.

The output ripple is essentially composed of two parts. One is caused by the inductor current ripple going through the Equivalent Series Resistance ESR of the output capacitors and the other is caused by the inductor current ripple charging and discharging the output capacitors. To achieve small output voltage ripple, choose a low-ESR output capacitor like Ceramic capacitor. For ceramic capacitors, the capacitance dominates the output ripple. For simplification, the output voltage ripple can be estimated by Equation 16 desired.

---

Application Waveforms

Vin=48V, Vout=12V, unless otherwise noted

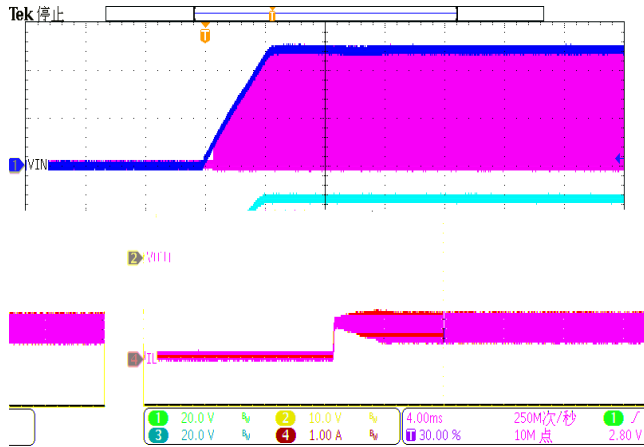

Figure 12. Power up (Iload=0.6A)

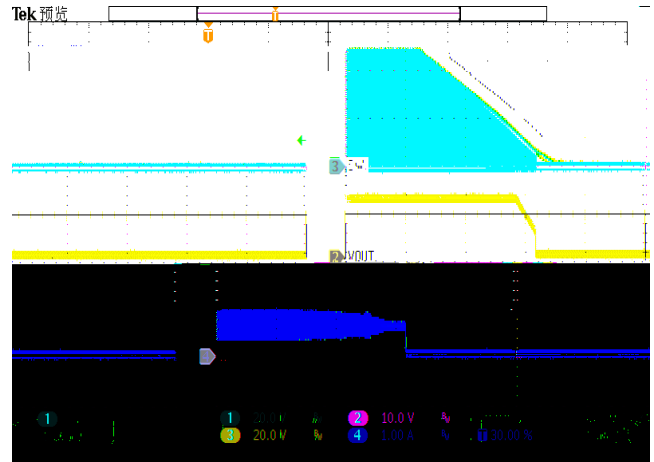

Figure 13. Power down (Iload=0.6A)

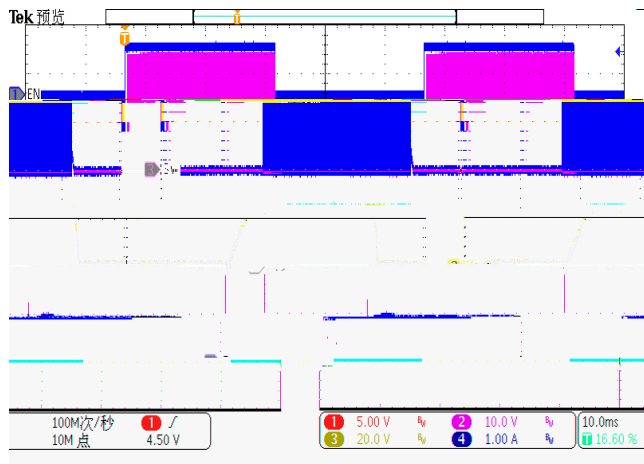

Figure 14. EN toggle (Iload=0.6A)

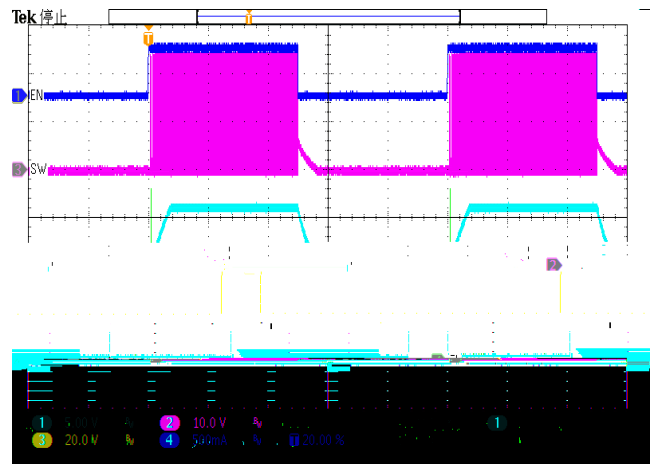

Figure 15. EN toggle (Iload=10mA)

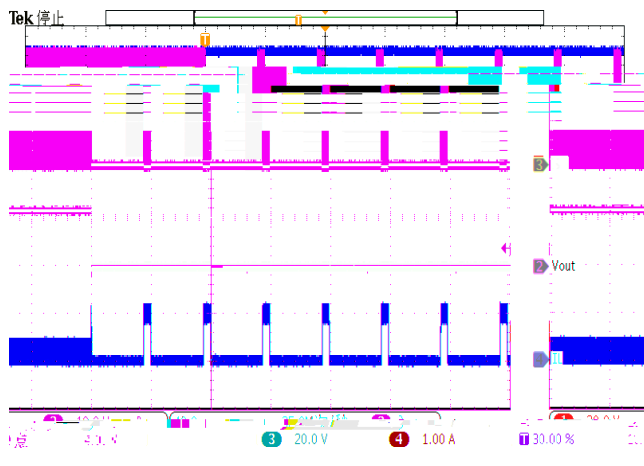

Figure 16. Over Current Protection (0.1A to hard short)

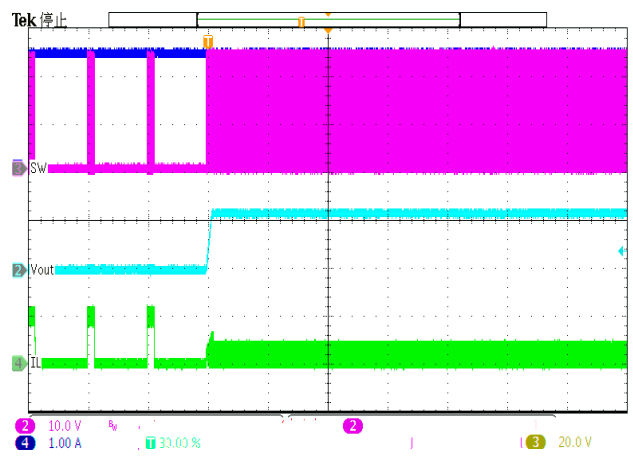

Figure 17. Over Current Release (hard short to 0.1A)

# SCT2A00

---

## Application Waveforms(continued)

Vin=48V, Vout=12V, unless otherwise noted

Figure 18. Load Transient (0.06A-0.54A, 1.6A/us)

Figure 19. Load Transient (0.15A-0





TAPE AND REEL INFORMATION

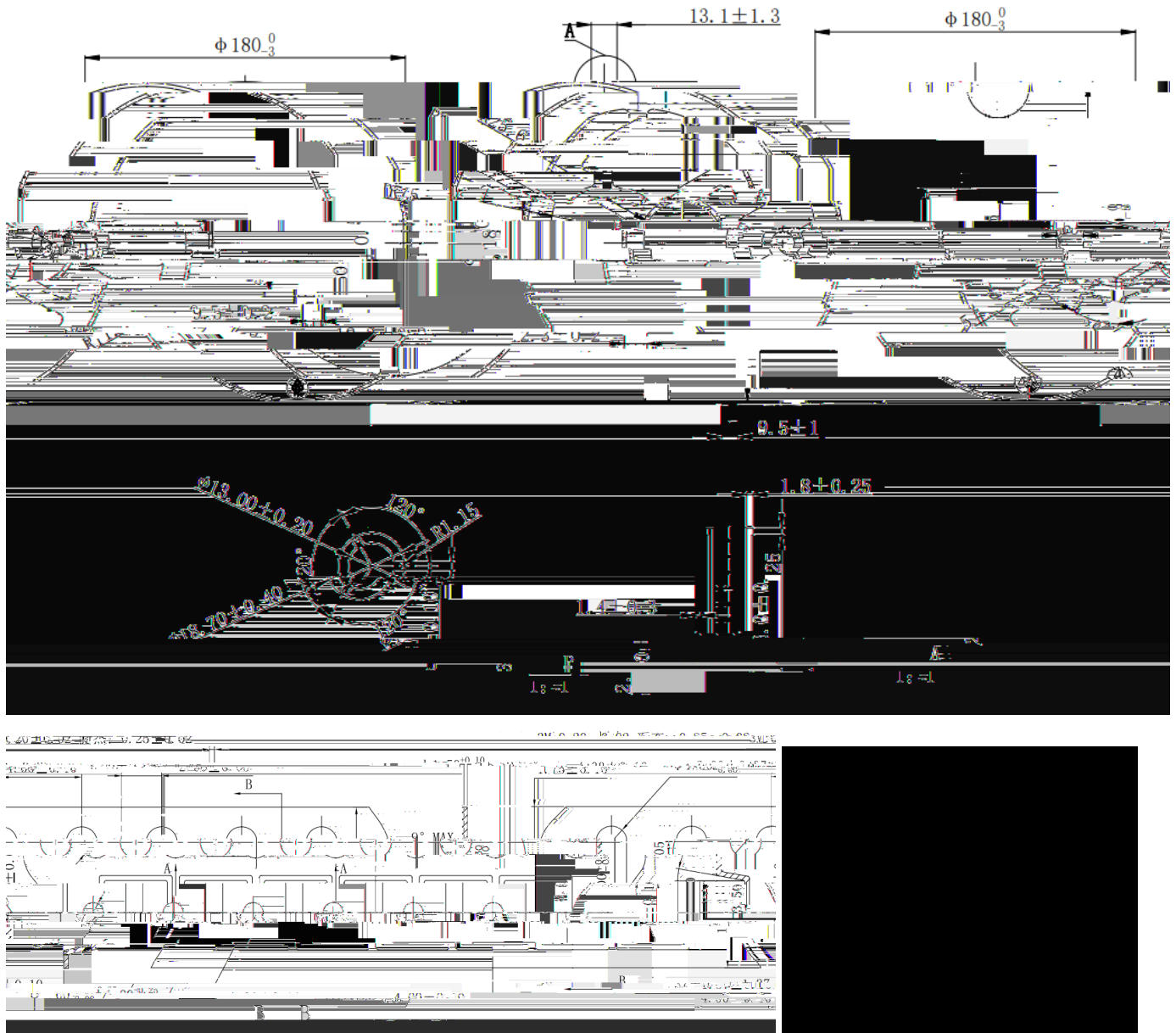

**NOTICE:** The information in this document is subject to change without notice. Users should warrant and guarantee the third party Intellectual Property rights are not infringed upon when integrating Silicon Content Technology (SCT) products into any application. SCT will not assume any legal responsibility for any said applications.