



REVISION HISTORY

DEVICE ORDER INFORMATION

ABSOLUTE MAXIMUM RATINGS

Over operating free-air temperature unless otherwise

RECOMMENDED OPERATING CONDITIONS

ESD RATINGS

(1)
(2)

THERMAL INFORMATION

ELECTRICAL CHARACTERISTICS

FUNCTIONAL BLOCK DIAGRAM

EN

FB

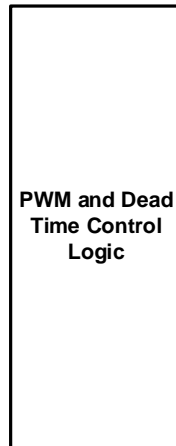
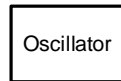

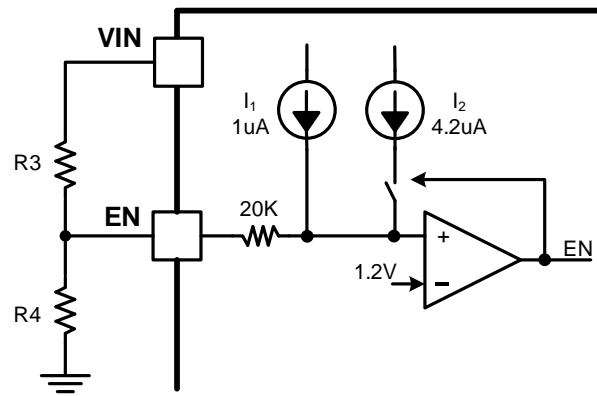

(6)

(7)

(8)

(9)

(10)

(12)



Figure 12. Power Up, IOU=3A

Figure 13. Power Down, IOU=3A

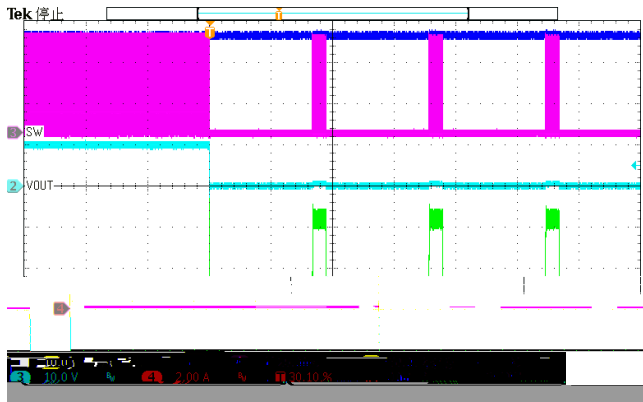

Figure 18. Over Current Protection(0A to hard short)

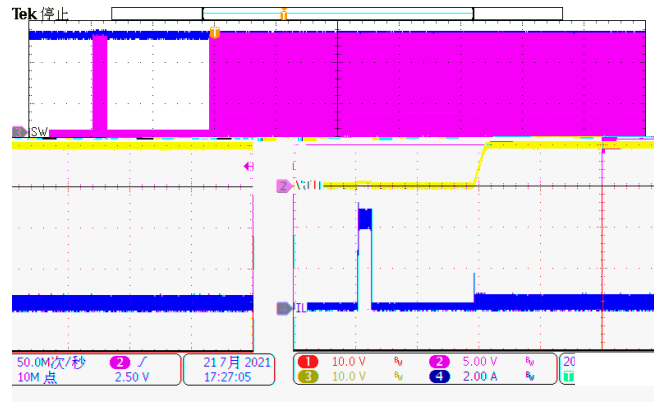

Figure 19. Over Current Release (hard short to 0A)

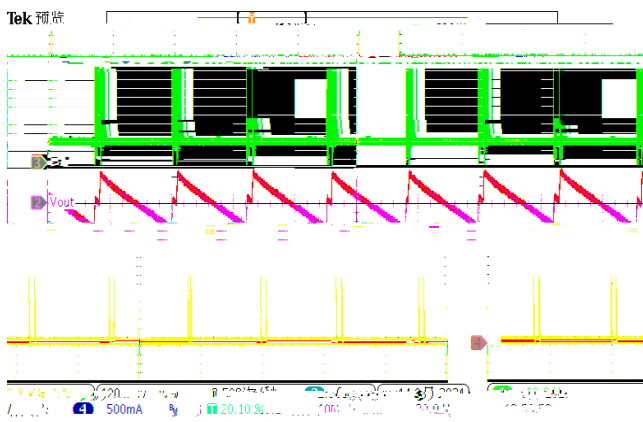

Figure 20. Output Ripple (Iload=10mA)

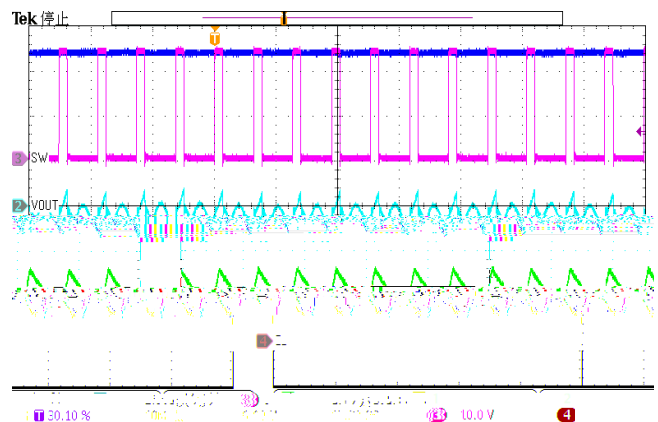

Figure 21. Output Ripple (Iload=1A)

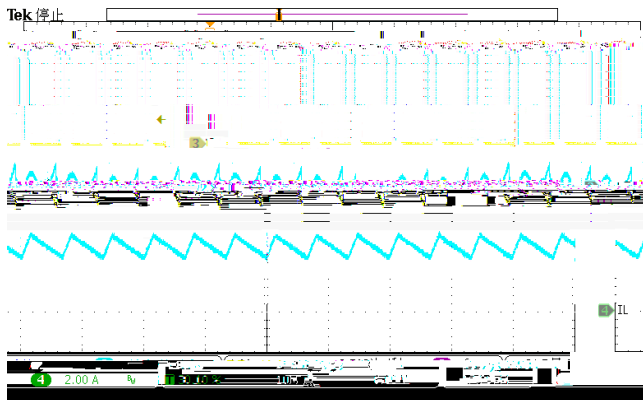

Figure 22. Output Ripple (Iload=3A)

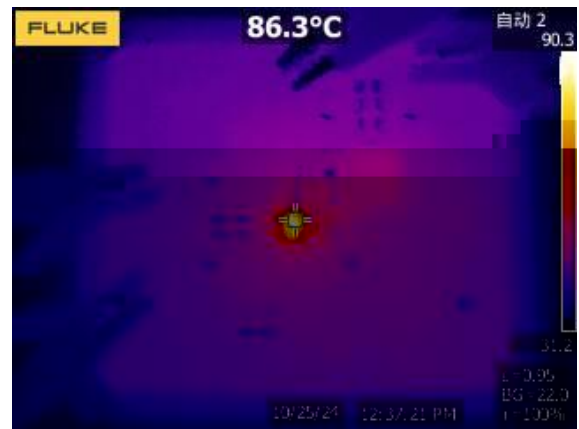

Figure 23. Thermal, 12VIN, 5Vout, 3A

1.

2.

3.

4.

TAPE AND REEL INFORMATION

